

4

3

2

1

D

D

C

C

B

B

A

A

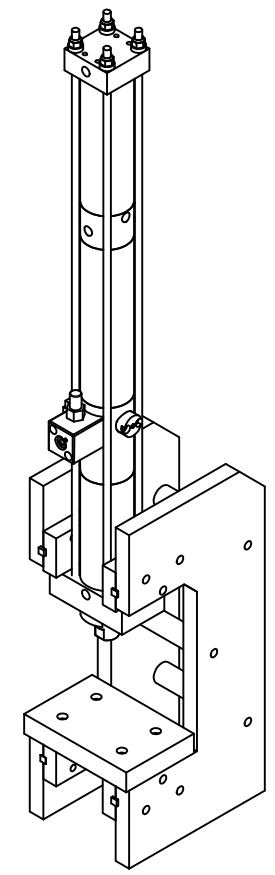
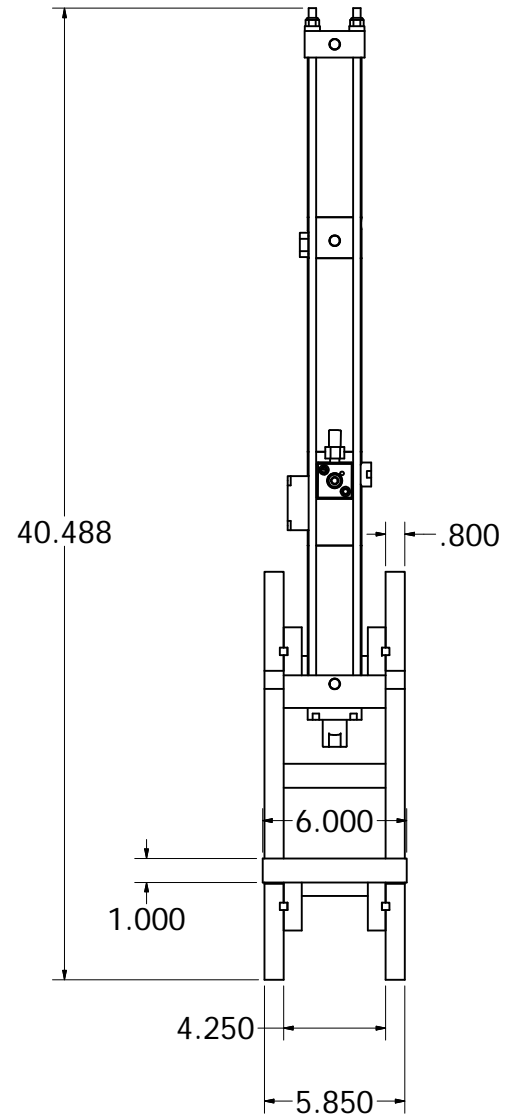
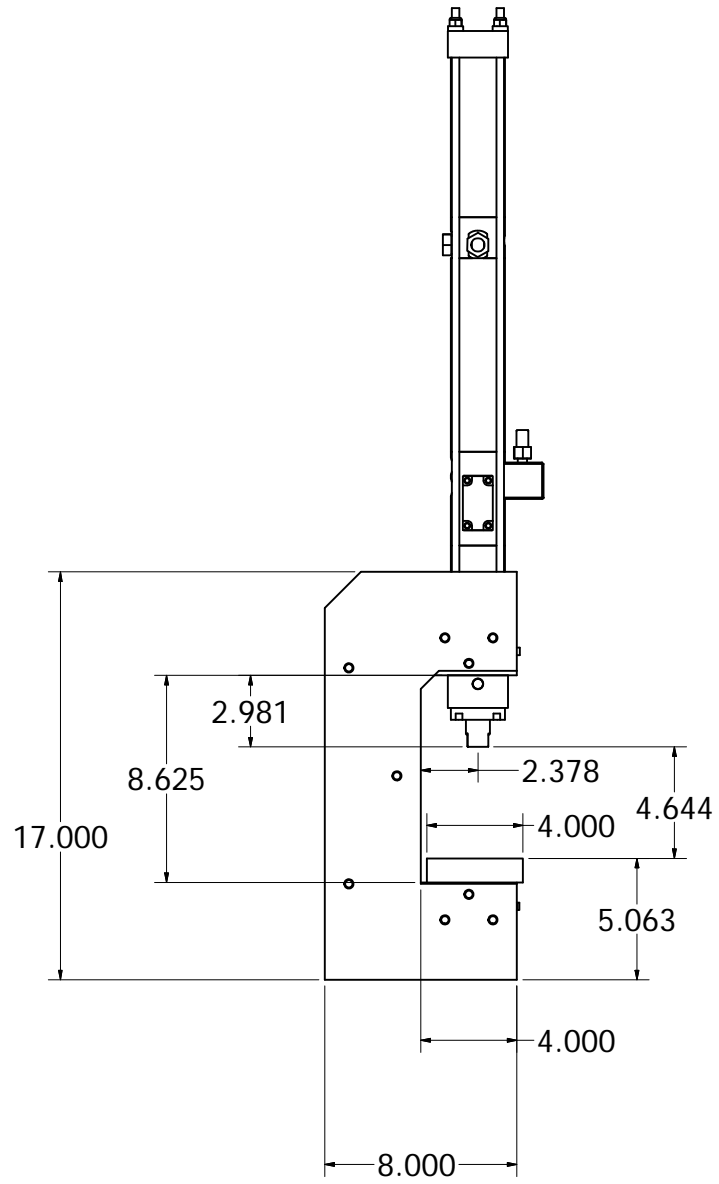

Notes
 1. REMOVE ALL: BURRS & POLISH ALL SHARP EDGES
 2. ALL SPECIFIED TOLERANCES ARE CRITICAL, ALL OTHERS +/-0.005

DRAWN Nick Sallinen	4/6/2010	POWER PRODUCTS INC.
CHECKED Nick Sallinen	4/16/2010	PROJECT C-Frame
DRAWING REV.	A	TITLE 8 NMK 2 Ton 2 TS
MODEL REV.	A	AS-CFrame2Ton-2TS-SignOff
		SHEET 1 OF 1

4

3

4

2

1