

4

3

2

1

D

D

C

C

B

B

A

A

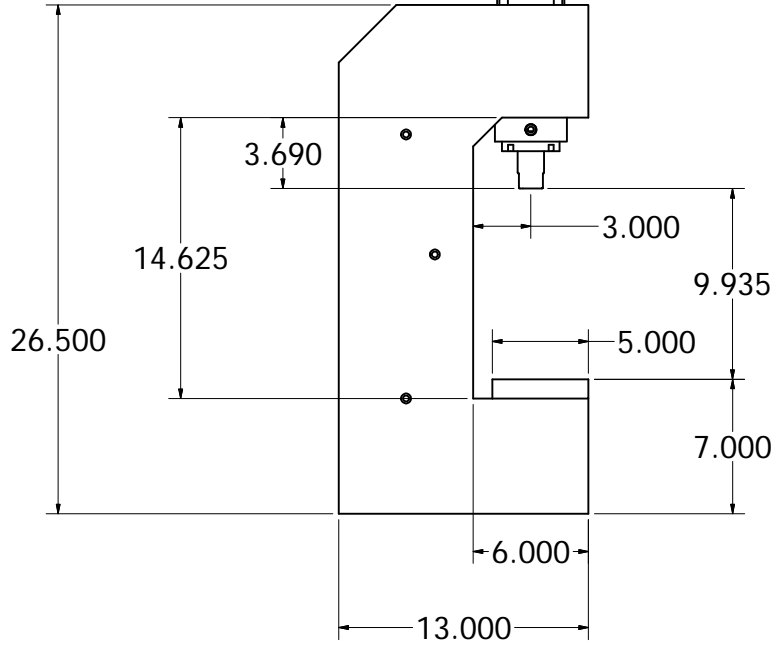
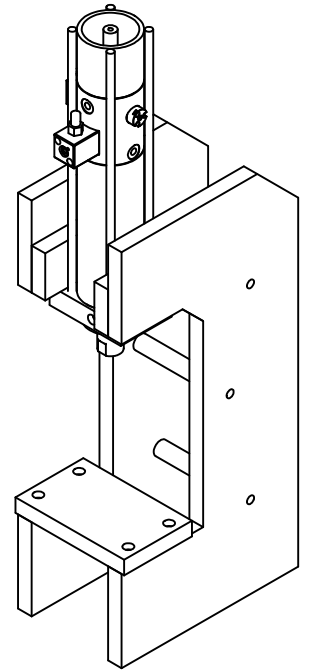
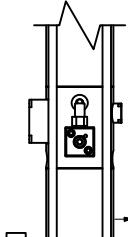
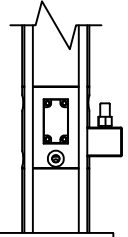
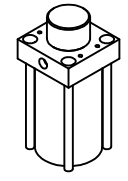
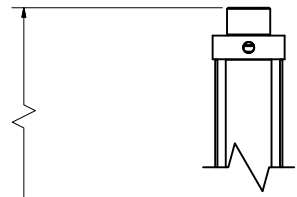
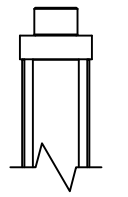

62.889

1.000

1.000

5.625

7.625

Notes
 1. REMOVE ALL: BURRS & POLISH ALL SHARP EDGES
 2. ALL SPECIFIED TOLERANCES ARE CRITICAL,
 ALL OTHERS +/-0.005

DRAWN Nick Sallinen	4/27/2010	POWER PRODUCTS INC.
CHECKED		PROJECT
DRAWING REV.		TITLE
MODEL REV.		
		SHEET 1 OF 1

4

3

4

2

1